

01
A 3

MẶT BẰNG TẦNG 1

TỶ LỆ

1/25

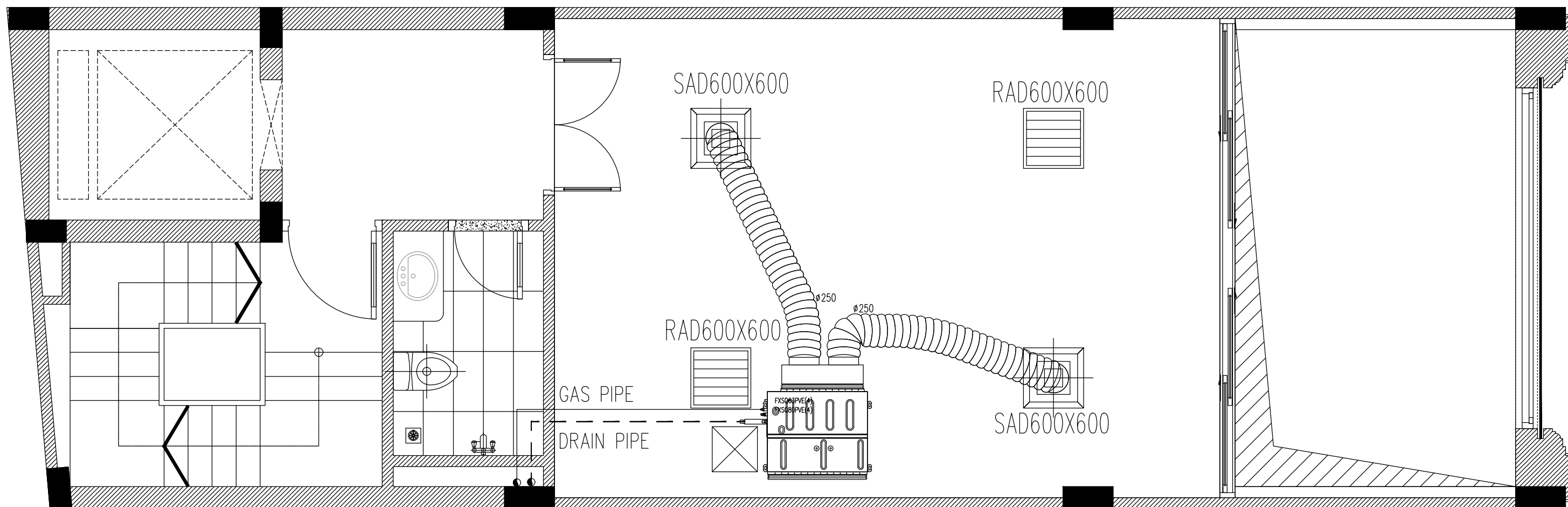

AC-02
7.1 kW

01
A 3

MẶT BẰNG TẦNG LỬNG TẦNG 1

TỶ LỆ

1/25

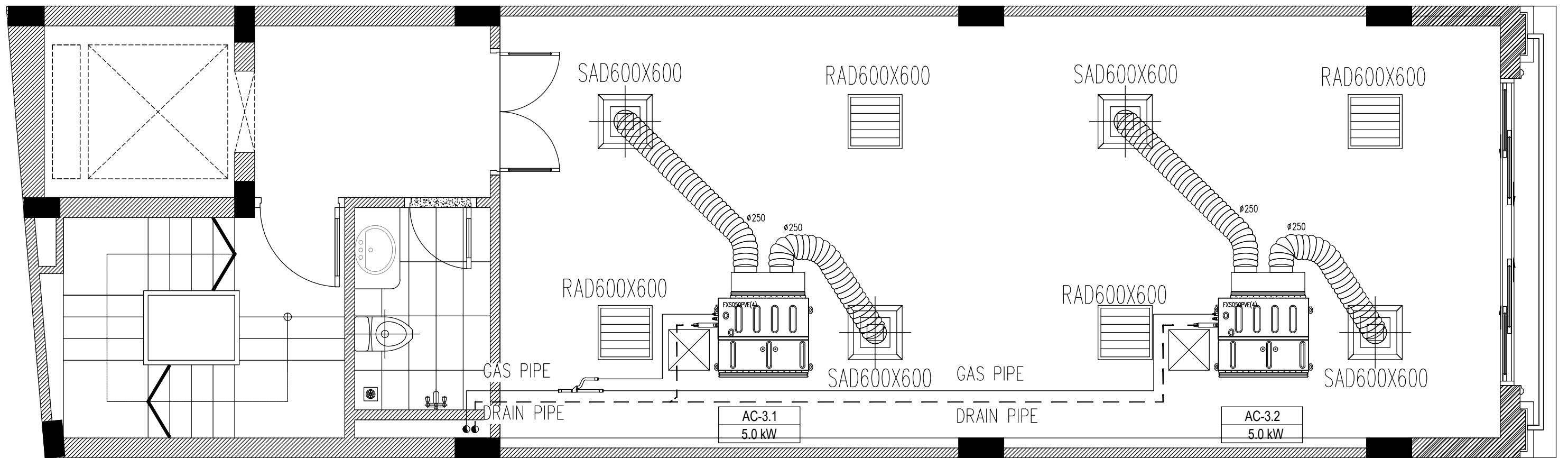

01
A 3

MẶT BẰNG CÁC TẦNG 2

TỶ LỆ

1/25

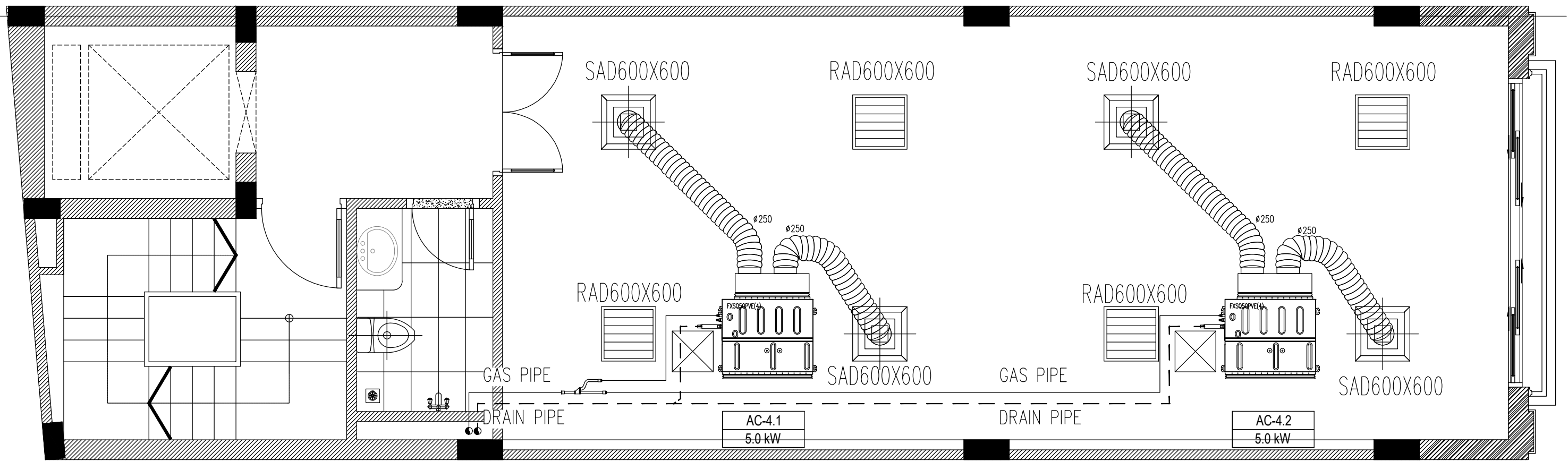

01
A 3

MẶT BẰNG CÁC TẦNG 3

TỶ LỆ

1/25

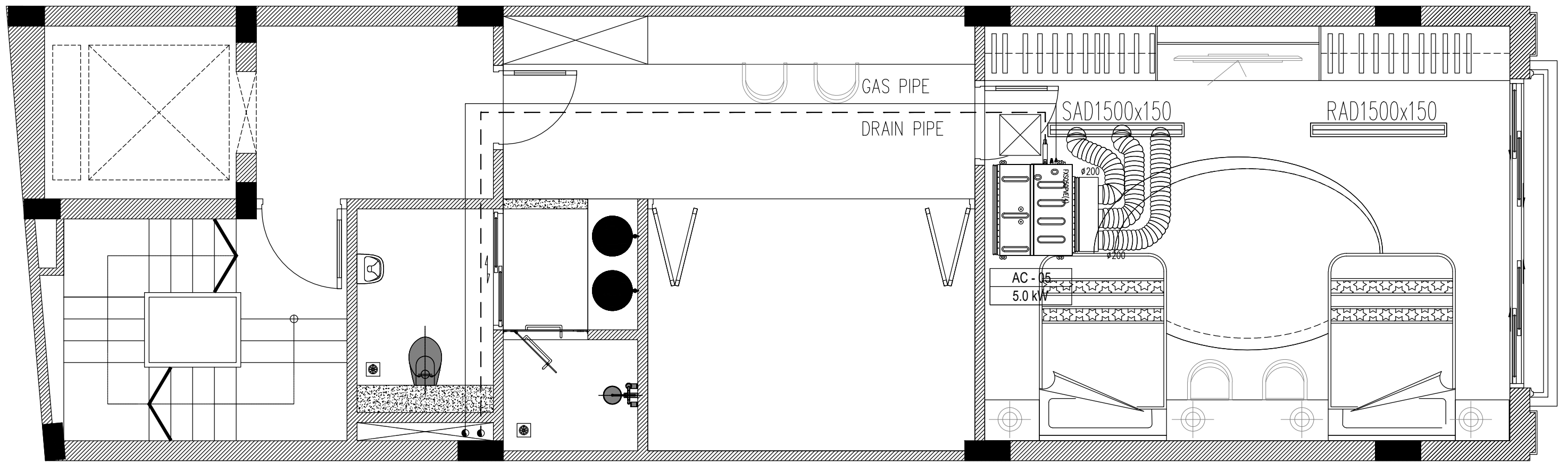

01
A 3

MẶT BẰNG TẦNG 4

TỶ LỆ

1/25

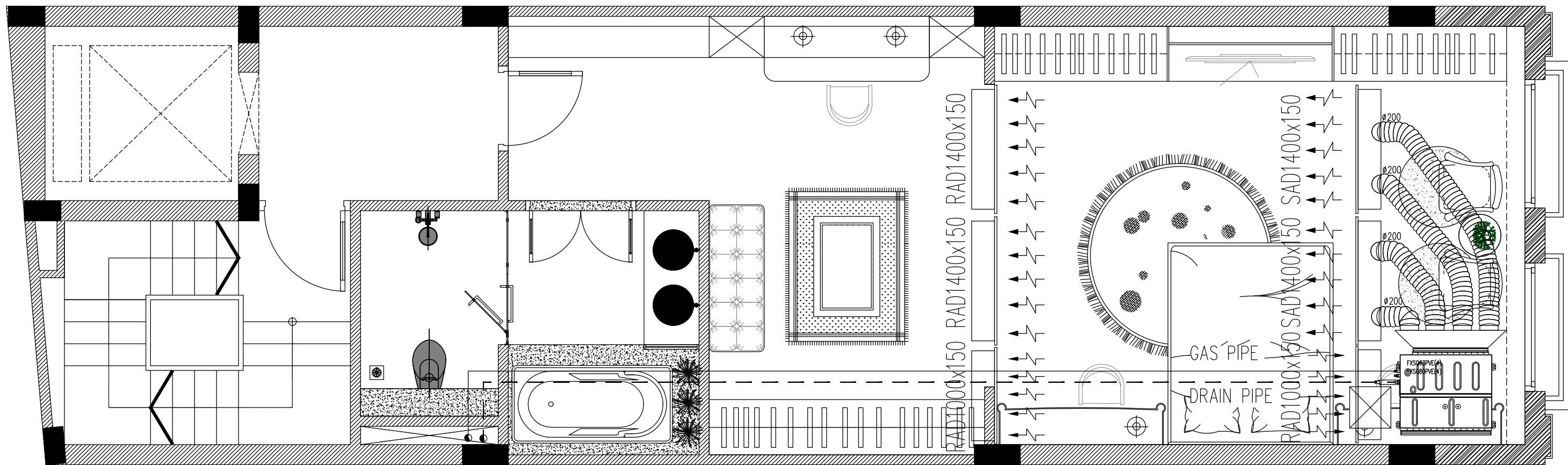

AC - 06
9.0 kW

01 MẶT BẰNG TẦNG 5
A 3 TỶ LỆ 1/25

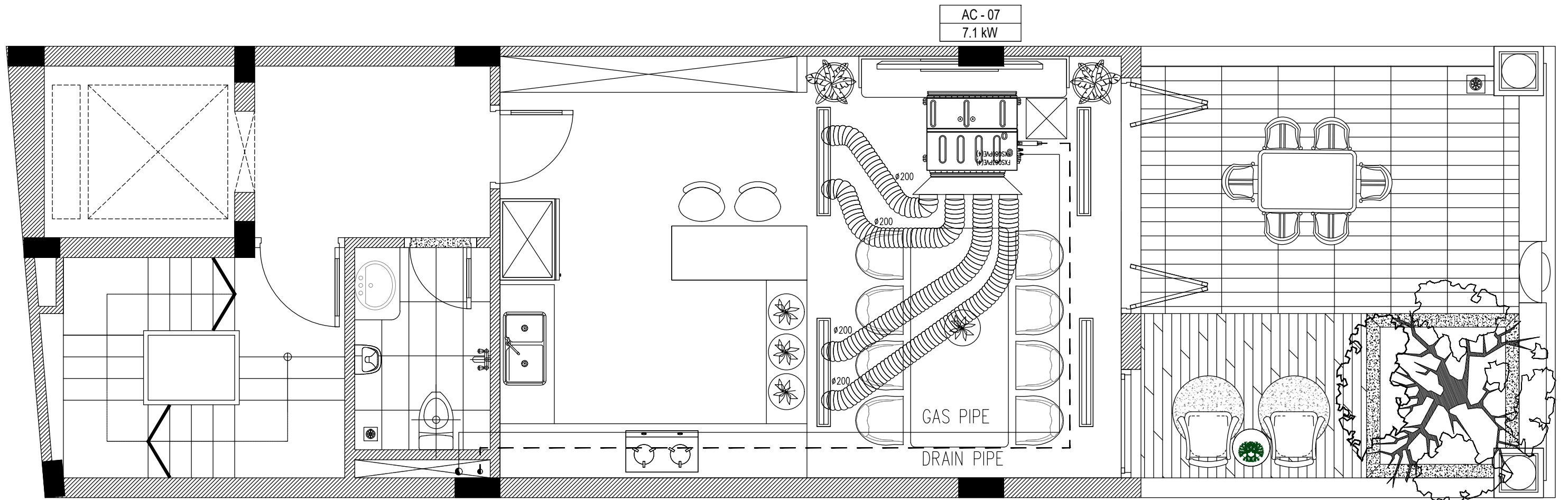

01
A 3

MẶT BẰNG TẦNG 6

TỶ LỆ

1/25

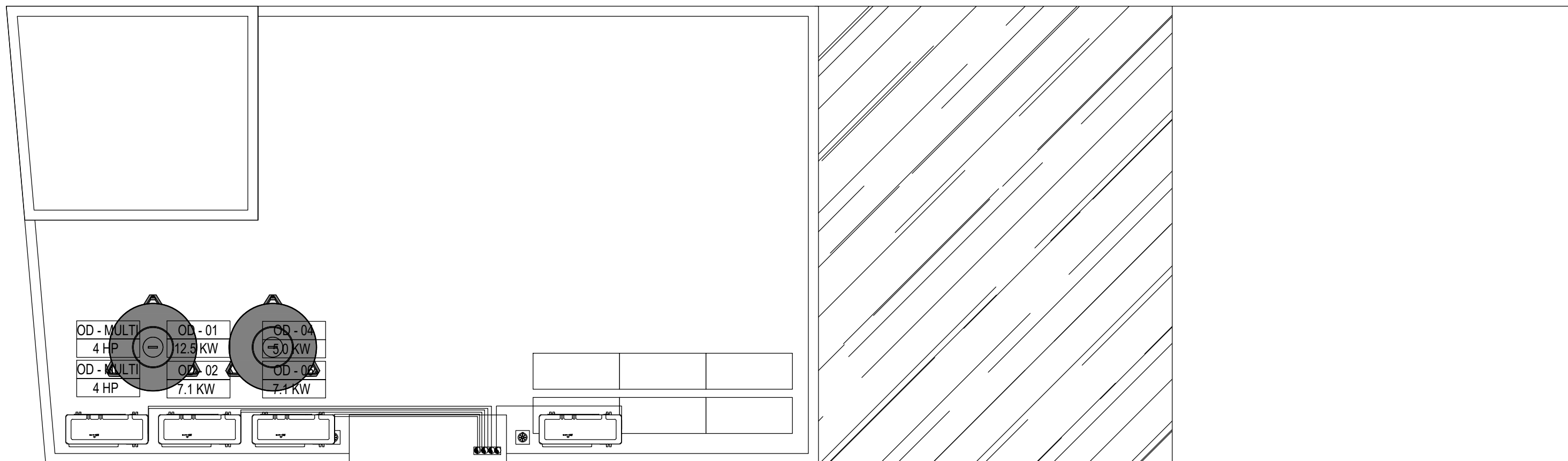

OD - 05
9.0 KW

01
A | 3

MẶT BẰNG MÁI CÔNG TRÌNH

TỶ LỆ

1/25